

MAINTENANCE

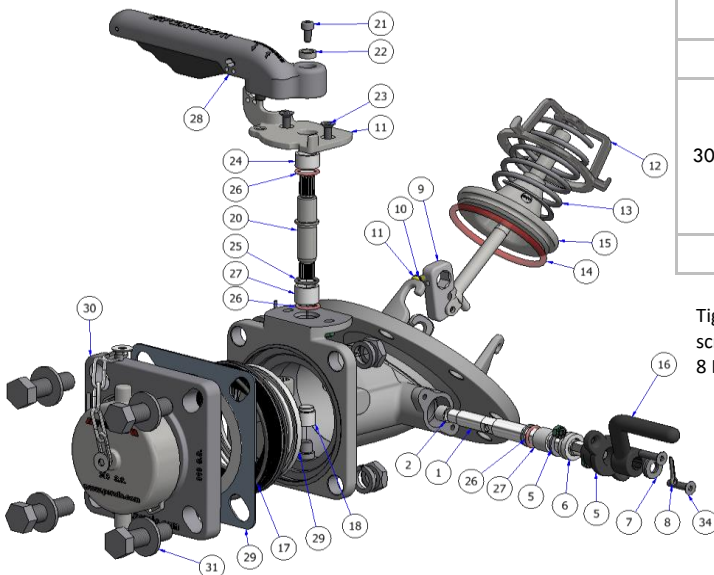

ITEM	QTY	DESIGNATION	PART N°
Spindle:			
1	1	Spindle, stainless steel	11 11 14 00 05
Spindle seals kit: 11 11 73 93 00			
8	1	Split pin, stainless steel	-
7	2	Washer, stainless steel	-
6	1	Packing gland, PTFE	12 85 30 30 00
5	1	Packing ring, stainless steel	-
27	1	Spindle bush, PTFE & glass 25%	12 85 30 00 03
26	1	O'ring, FEP/Silicon	70 10 15 00 12
2	1	Spindle bush, PTFE	12 85 30 00 05
-	2	Screw M6-25, stainless steel	-
Pushrod kit: 11 16 01 92 00			
9	1	M6-8 screw, stainless steel	-
10	1	M6 washer, stainless steel	-
11	1	Crank & pushrod, stainless steel	11 16 01 30 00
Bayonet cap & spring:			
18	1	Bayonet cap, stainless steel	11 16 01 00 04
17	1	Spring, stainless steel	12 85 38 00 02
Poppet kit: 111149700mk2			
15	1	Poppet, stainless steel	11 16 01 70 00
14	1	O'ring, FEP/Silicon	70 10 15 00 53
Closure plate kit: 12 85 57 81 00			
17	1	Closure plate, stainless steel	11 14 85 20 00
18	1	Closure plate bush, PTFE & glass	12 85 57 00 04

ITEM	QTY	DESIGNATION	PART N°
Butterfly valve spindle kit:			
20	1	Short spindle, Duplex / 1.4462	17 12 88 00 01
Butterfly valve spindle and seals kit: 11 12 62 97 00			
27	1	Spindle bush, PTFE & glass 25%	12 85 30 00 03
26	2	O'rings, FEP & silicon	70 10 15 00 12
23	2	Screw, Nuts & Washer stainless steel	-
21	2	Screw M6-12, Stainless steel	-
22	1	Ring washer, Stainless steel	-
24	1	Short Spindle bush, PTFE & glass 25%	11 12 62 00 01
25	1	O'ring, FKM/Viton	70 10 01 02 12
Closure plate seal kit: 12 85 57 94 00			
19	1	Closure plate seal, PTFE	12 85 57 00 01
Ring clamp kit: 12 85 57 95 00			
39	1	O'ring, Nitrile	70 10 03 07 05
32	1	Ring clamp, stainless steel	12 85 57 00 02
Butterfly valve handle kit: 11 14 85 90 00			
28	1	Handle, stainless steel	11 14 54 40 00
21	1	Screw M6-12, stainless steel	-
22	1	Ring washer, stainless steel	-
Footvalve handle kit: 12 85 24 93 00			
16	1	Handle, stainless steel	11 11 69 0A 00
8	1	Split pin	-
7	1	Washer	-
Bolting kit: 11 16 92 30 00			
31	4	M16 screw, stainless steel	-
	4	M16 washer, stainless steel	-
	4	W16 grower washer, stainless steel	-
	4	Nut, stainless steel	-
Outlet nozzle kit: 12 85 69 00 00			
30	1	Chain, stainless steel	-
	1	Cap seal, PTFE	12 85 59 00 01
	1	Cap, stainless steel	12 85 59 30 01
	1	Outlet nozzle square, stainless steel	12 85 69 60 00
CNAF/PTFE Gasket (item 29): 12 91 42 00 00			



Tightening torque 2 screws stuffing clap:
8 N.m

Nb: Perolo recommends the spindle seals should be changed simultaneously to maintain the valve spindle perfectly tight.

BOTTOM DISCHARGE